

7._TURNITIN_DERMAWAN.pdf

by

FILE	7._TURNITIN_DERMAWAN.PDF (576.31K)	WORD COUNT	2553
TIME SUBMITTED	01-JUL-2020 09:04AM (UTC+0700)	CHARACTER COUNT	12829
SUBMISSION ID	1352035570		

Finite element analysis on vibration of a flexible single-link manipulator moved translationally

D Dermawan^{1,2,*}, H Abbas¹, R Syam¹, Z Djafar¹, A K Muhammad²

¹Department of Mechanical Engineering, Hasanuddin University, Indonesia 90245

²Department of Mechanical Engineering, State Polytechnic of Ujung Pandang, Indonesia 90245

*E-mail: dermawan@poliupg.ac.id

Abstract. The objectives of this study are to formulate the equation of motion of a flexible single-link manipulator system and to develop computational codes by a finite-element method in order to perform dynamics simulation on vibration of the manipulator system. The system used in this research consist of an aluminium beam as a flexible link, a clamp-part to hold the link, a DC motor and a lead screw set to move the link translationally. Computational codes on time history responses and FFT (Fast Fourier Transform) processing were developed to calculate dynamic behaviour of the link. The simulation result show the dynamic behaviour of the system on free vibration and forced vibration by excitation force due to the translational motion of the single-link manipulator system.

Keywords: Finite-element method, flexible manipulator, translational motion.

1. Introduction

In industrial applications and robotics system, a single-link flexible manipulator is expected to achieve maximum workability during operations such as high speed with safe operation, improved positioning accuracy, lighter weight, and lower energy consumption. Problems that often arise in flexible-link manipulator are vibrations caused by its flexibility which causes deformations that interfere with the performance of the system.

In the last decade, a number of researchers have investigated dynamic behaviour of flexible manipulator. Muhammad et al investigated dynamic of flexible manipulator with rotational motion using finite-element method including vibration control [1]–[8]. Muhammad et al used two node element in the investigation.

This study aims to formulate the equation of motion of the system and to develop computational codes with finite-element methods to find out time history responses and FFT (Fast Fourier Transform) processing of the link. The results of the plot time history response and FFT generated the natural frequency of the system.

Grounded in the previous work on computer simulation of a flexible single-link manipulator [8] and a flexible two-link manipulator [3] which failed to include the translational motion, this study put an emphasis on the translational motions in which these motions are often used in industrial applications and robotics. Another previous study also reported that the result of numeric simulation of a two-link

flexible manipulator was used to verify the control scheme effectively [9]. In relation to the current research, some similarities were also identified such as the use of a kinetic energy, potential energy, and Lagrange equation to derive the equation of motion[10]. Beyond the similarities, Bien's work focuses on translational and rotational joint of two-link manipulator while this piece of work focuses on translational motion with a clamp-part to hold the link.

Prior to the application of active-force control on vibration of a single-link manipulator [2], it is necessary to have a clear picture of the characteristic of the link without vibration control. Obtaining the value of the free vibration is necessary to find out the natural frequency of the link. Furthermore, the natural frequency is pivotal to determine the type of effective control.

2. Formulation by finite-element method

Grounded in finite-element method [11], each partition of the link is partially calculated to find out the matrix of mass (M) and stiffness (K) which generated a natural frequency of system. The link with a cantilever structure with a length of 33 cm is divided into 6 elements and move translationally by a DC motor to determine the vibration characteristics of the link. The degrees of freedom of the finite-element are divided into two types namely the lateral deformation $v(t)$ and the rotational angle $\psi(t)$. The physical properties of the system consists of the length (L_i), the cross-sectional area (S_i), and the area moment of inertia (I_i). Each element of the mechanical properties (Young's modulus and mass density) are denoted as E_i and ρ_i .

2.1. Kinematics

Some text Figure 1 plots the directions of translational motion on the link into three types namely the displacement (Y), velocity (\dot{Y}), and acceleration (\ddot{Y})

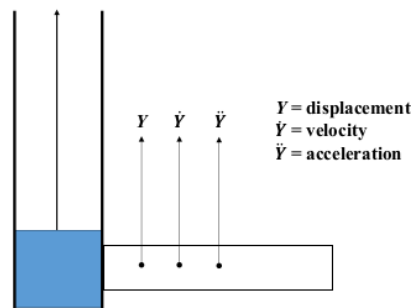

Figure 1. Directions of translational motion on the link

Figure 2 shows the position vector of point P on the link in the global coordinate frame and translating coordinate frame. $O - XY$ is the global coordinate frame and $O - yx$ is the translational coordinate frame. When the link move translationally, the displacement at X axis is x_p and the displacement at Y axis is Y_p . The deflection due to the translational motion is denoted as v_p . The vector position $r(x, t)$ at point P on the link at time $t = t$, in the global coordinate frame $O - XY$ shown in the figure 2 is given by:

$$r(x, t) = X_p(x, t)\mathbf{I} + Y_p(x, t)\mathbf{J} \quad (1)$$

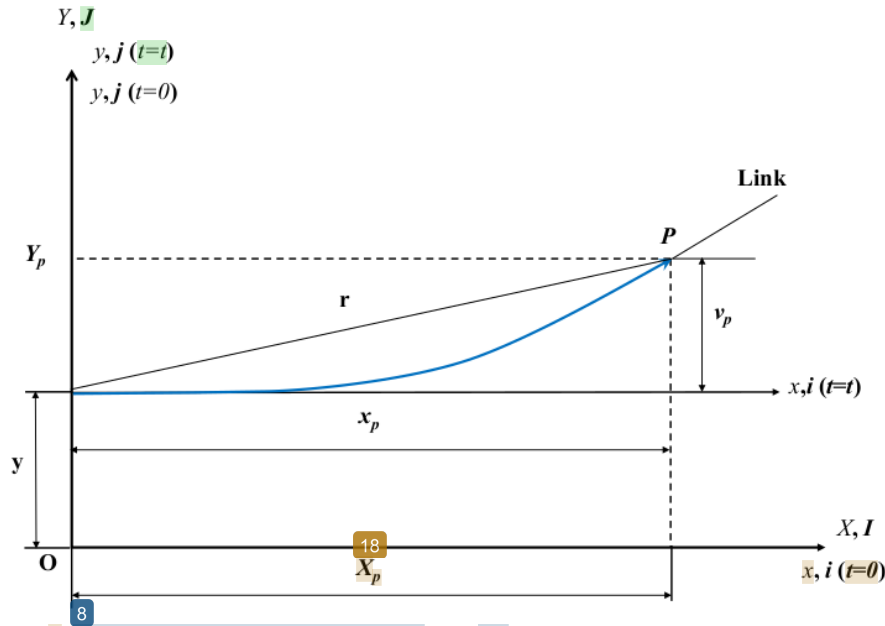

Figure 2. Position vector of an arbitrary point P of the link in the translational coordinate frames

The position vector of P in frame $O - XY$ is

$$X_p(x, t) = x_p \tag{2}$$

$$Y_p(x, t) = y + v_p \tag{3}$$

The velocity vector of P in frame $O - xy$, given by

$$\dot{r}(x, t) = \dot{X}_p(x, t)I + \dot{Y}_p(x, t)J \tag{4}$$

2.2. Finite-element method

Figure 3. illustrates the partitions of the link which are divided into six elements. Each node has the lateral deformation $v(t)$ and the rotational angle $\Psi(t)$.

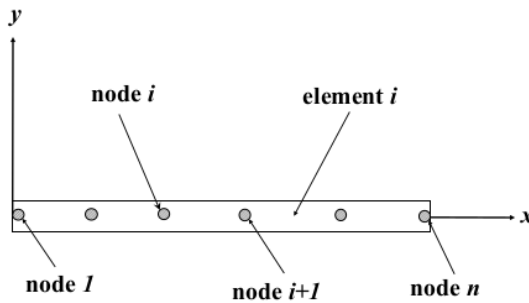

Figure 3. Translating coordinate frame of the link

Then, figure 4 shows the element coordinate frame of the i -th element.

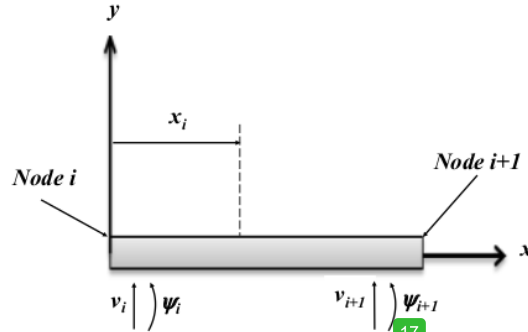

Figure 4. Element coordinate frame of the i -th element

The nodal displacement vector is

$$\delta_i = \{v_i \quad \varphi_i \quad v_{i+1} \quad \varphi_{i+1}\}^T \quad (5)$$

2.3. Equation of motion

The discretization generated from the previous section, the velocity square of P can be obtained

$$\dot{\mathbf{r}}^T \cdot \dot{\mathbf{r}} = \dot{x}_p^2 + \dot{y}^2 + \dot{v}_p^2 + 2\dot{y}\dot{v}_p \quad (6)$$

The kinetic energy (T_i) of system can be given by

$$T_i = \int_{v_i} \rho_i \cdot \dot{\mathbf{r}}^T \cdot \dot{\mathbf{r}} \cdot dv_i \quad (7)$$

The kinetic energy (T_i) of system can be expressed as

$$T_i = \frac{1}{2} m_i \dot{x}_p^2 + \frac{1}{2} m_i \dot{y}^2 + \frac{1}{2} \dot{\delta}_i^T \mathbf{M}_i \dot{\delta}_i + \dot{y} f_{ti}^T \dot{\delta}_i \quad (8)$$

Where

$$\dot{y} f_{ti}^T \dot{\delta}_i = \frac{m_i}{12} [6 \quad l_i \quad 6 \quad -l_i]$$

The potential energy of the system can be written as

$$U_i = \frac{1}{2} \delta_i^T K_i \delta_i \quad (9)$$

The dynamic model is formulated using the Lagrange equation can be defined by

$$M_i \ddot{\delta}_i - \dot{y}(t) f_{ti}^T + C_i \dot{\delta}_i + K_i \delta_i = 0 \quad (10)$$

The equation of motion of the i -th element is given by:

$$M_i \ddot{\delta}_i + C_i \dot{\delta}_i + K_i \delta_i = \dot{y}(t) f_{ti}^T \quad (11)$$

Where mass matrix (M_i), damping matrix (C_i), stiffness matrix (K_i), and the excitation force of the translation motion ($\ddot{y}(t)f_{ti}^T$)

Matrix M_i , C_i , K_i and vector $\ddot{y}(t)f_{ti}^T$ in Eq. (11) are represented as

$$M_i = \frac{\rho_i S_i L_i}{420} \begin{bmatrix} 156 & 22L_i & 54 & -13L_i \\ 22L_i & 4L_i^2 & 13L_i & -3L_i^2 \\ 54 & 13L_i & 156 & -22L_i \\ -13L_i & -3L_i^2 & -22L_i & 4L_i^2 \end{bmatrix} \quad (12)$$

$$K_i = \frac{E_i I_{zi}}{L_i^3} \begin{bmatrix} 12 & 6L_i & -12 & 6L_i \\ 6L_i & 4L_i^2 & -6L_i & 2L_i^2 \\ -12 & -6L_i & 12 & -6L_i \\ 6L_i & 2L_i^2 & -6L_i & 4L_i^2 \end{bmatrix} \quad (13)$$

$$C_i = \alpha \cdot K_i \quad (14)$$

$$f_{ti}^T = -\frac{\rho_i S_i L_i}{12} \{6, l_i, 6, -l_i\} \quad (15)$$

The length of the i -th element, the length from element 1 to i , and the Rayleigh damping factor are denoted by l_i , l_{i-} , and α [12] respectively

In the end, the equation of motion of the single-link with n element considering the boundary conditions is written by

$$M_n \ddot{\delta}_n + C_n \dot{\delta}_n + K_n \delta_n = \ddot{y}(t)f_{tn} \quad (16)$$

3. Dynamic behaviour of the system

3.1. Computational model 6

Figure 5 illustrates the system of a flexible single-link manipulator which has a track of the link, clamp as the holder of the link, a servo motor to rotate the link, and a DC motor to make a translation motion.

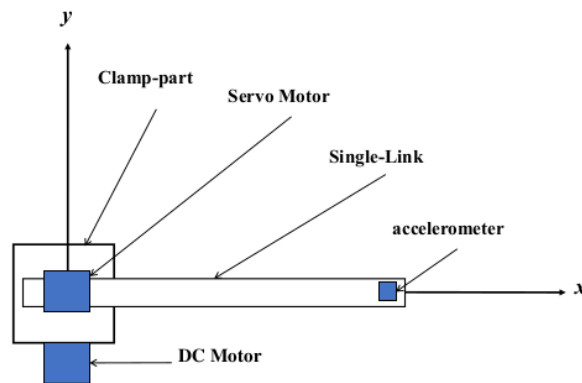

Figure 5. Model system of flexible Single-link manipulator

3.2. Physical parameters of dynamic models

13 Table 1. Physical parameters of the link

Property	Symbol	value
Total length (m)	L	3.30×10^{-1}
11 Length of the link (m)	l_i	3.00×10^{-1}
breadth of cross section (m)	b_i	2.50×10^{-2}
height of cross section (m)	h_i	1.00×10^{-3}
Cross section area of the link (m ²)	S_i	1.95×10^{-5}
Cross section area moment of inertia around i -axis of the link (m ⁴)	I_i	2.75×10^{-12}
Young's Modulus of the link (GPa)	E_i	7.00×10^1
Density of the link (kg/m ³)	ρ_i	2.70×10^3
Damping factor of the link	α	0.10×10^{-3}

3.3. Time history response on free vibration

Time history response on free vibration simulation on free vibration was conducted using an impulse force as an external one. Figure 6 shows the simulation time history response of lateral deformation v_p on the free vibration. Furthermore, the computational codes on time history response of single-link were developed. Figure 6 shows the calculated lateral deformation at Node 6 of the system under the impulse force.

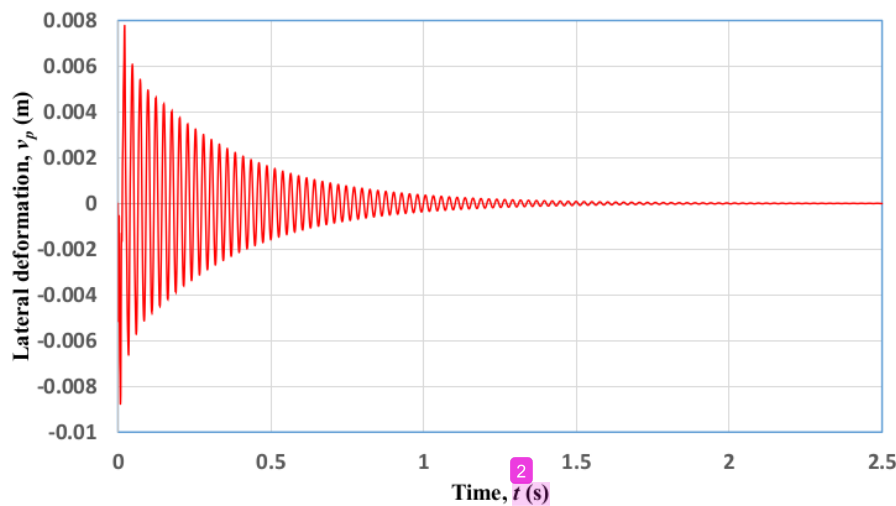

2 Figure 6. Time history response of the system

3.4. FFT (Fast Fourier Transform) Processing.

The calculated result from time history response to lateral deformation with free vibration on the system was transferred by FFT processing to find its frequencies. Figure 7 shows the calculated natural frequencies of the flexible link manipulator. The first, second, and third natural frequency are 38.57 [Hz], 109.37 [Hz], and 174.32 [Hz].

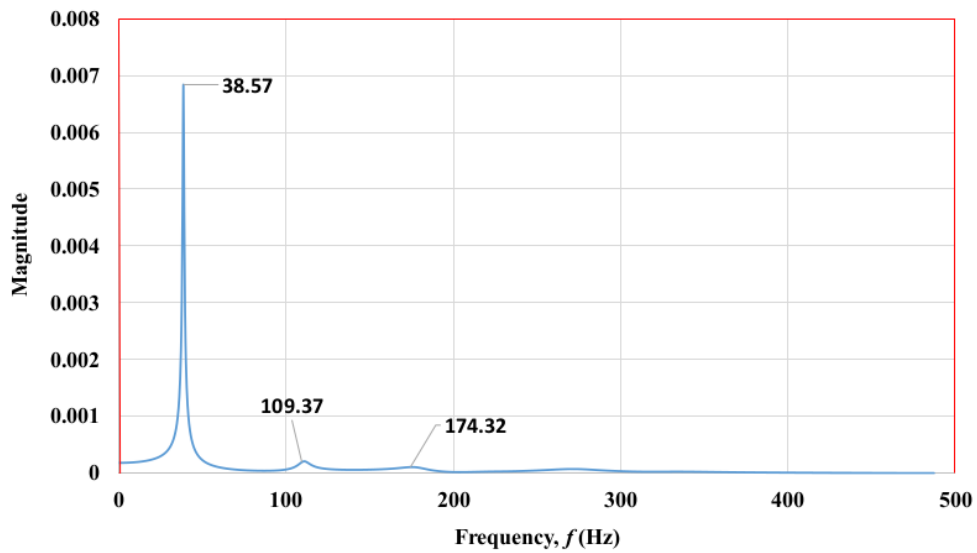

Figure 7. Calculated natural frequencies of the link

16

3.5. Time history response of the system with excitation force.

The calculated result from time history response to lateral deformation with excitation force on the system is shown in the figure 8. Showing at 0.5 (s) in the timeline, the lateral deformation becomes large due to the excitation force ($f_t = 5$).

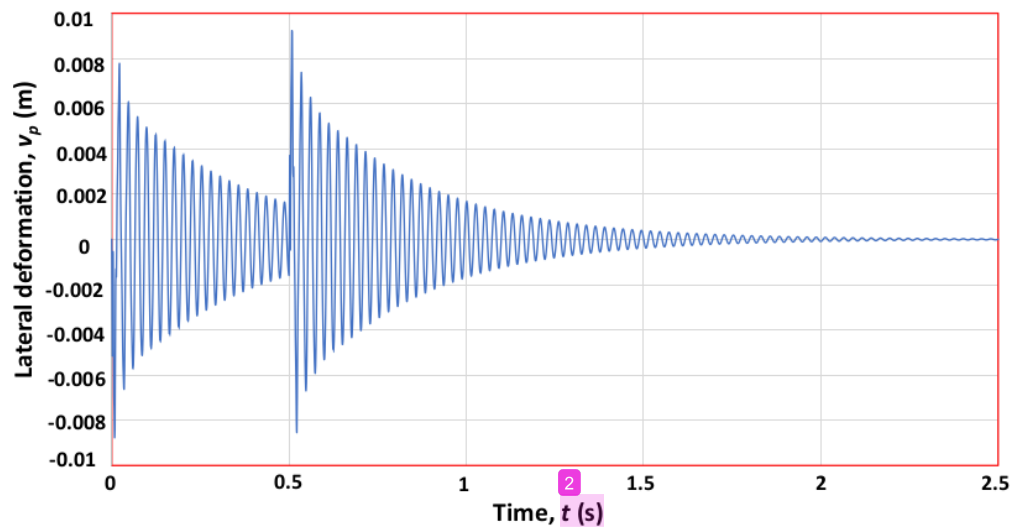

Figure 8. Time history response of the system with excitation force

9 Conclusions

The equation of motion on the single-link flexible manipulator moved translationally has been discretized using a finite-element method. The computational codes were developed to simulate the dynamic system using the Scilab application. The simulation and calculated result of time history response, natural frequencies, and vibration mode showed validated formulation, computational codes, and model system. Fast Fourier Transform (FFT) has also generated the first, second, and third natural frequencies values as (f1) 38.57 [Hz], (f2)109.37 [Hz], and (f3)174.32 [Hz].

Further research recommends to combine the translational and the rotational motion on the single-link flexible manipulator by finding the equation of translational and rotational motion. The further step will continue doing an experiment of the model.

References

- [1] A. K. Muhammad, S. Okamoto, and J. H. Lee, "Comparison Between the One Piezoelectric Actuator and the Two Ones on Vibration Control of a Flexible Two-Link Manipulator Using Finite Element Method," *Int. J. Mech. Eng.*, vol. **5**, no. 1, pp. 25–42, 2016.
- [2] A. K. Muhammad, S. Okamoto, and J. H. Lee, "Finite Element Analysis for Active-force Control on Vibration of a Flexible Single-link Manipulator," *Int. J. Smart Mater. Mechatronics*, vol. **2**, no. April, p. 18, 2016.
- [3] A. K. Muhammad, S. Okamoto, and J. H. Lee, "Computer Simulations and Experiments on Vibration Control of a Flexible Link Manipulator Using a Piezoelectric Actuator Computer Simulations and Experiments on Vibration Control of a Flexible Link Manipulator Using a Piezoelectric Actuator," *Eng. Lett.*, vol. **3**, no. 23, 2015.
- [4] A. K. Muhammad, S. Okamoto, and J. H. Lee, "Active-Force Control on Vibration of a Flexible Single-Link Manipulator Using a Piezoelectric Actuator," *Trans. Eng. Technol.*, pp. 1–15, 2015.
- [5] A. K. Muhammad, S. Okamoto, and J. H. Lee, "Active-Force Control on Vibration of a Flexible Single-Link Manipulator Using a Piezoelectric Actuator," in *Transactions on Engineering Technologies*, Springer, 2015, pp. 1–15.
- [6] A. K. Muhammad, S. Okamoto, and J. H. Lee, "Comparison of proportional-derivative and active-force controls on vibration of a flexible single-link manipulator using finite-element method," *Artif. Life Robot.*, vol. **19**, no. 4, pp. 375–381, 2014.
- [7] A. K. Muhammad, S. Okamoto, and J. H. Lee, "Comparisons of proportional and active-force controls on vibration of a flexible link manipulator using a piezoelectric actuator through calculations and experiments," *Eng. Lett.*, vol. **22**, no. 3, p. 8, 2014.
- [8] A. K. Muhammad, S. Okamoto, and J. H. Lee, "Computer simulations on vibration control of a flexible single-link manipulator using finite-element method," in *The Nineteenth International Symposium on Artificial Life and Robotics 2014*, 2014.
- [9] X. Yang and Z. Zhong, "Dynamics and Terminal Sliding Mode Control of Two-Link Flexible Manipulators with Noncollocated Feedback," *IFAC Proc. Vol.*, vol. **46**, no. 20, pp. 218–223, 2013.
- [10] D. X. Bien, C. A. My, and P. B. Khoi, "Dynamic Modeling and Control of a Flexible Link Manipulators with Translational and Rotational Joints," *VNU J. Sci. Math. – Phys.*, vol. **34**, no. 1, pp. 52–66, 2018.
- [11] S. S. Rao, *The finite element method in engineering*, Fifth Edit. Elsevier, 2011.
- [12] M. Lalanne, P. Berthier, and J. Der Hagopian, *Mechanical Vibrations for Engineers*. <cel-00315803> HAL, 1984.

ORIGINALITY REPORT

% **11**

SIMILARITY INDEX

% **1**

INTERNET SOURCES

% **9**

PUBLICATIONS

% **7**

STUDENT PAPERS

PRIMARY SOURCES

1

Giancarlo Genta. "Vibration of Structures and Machines", Springer Science and Business Media LLC, 1995

Publication

% **2**

2

Giancarlo Genta. "Vibration of Structures and Machines", Springer Science and Business Media LLC, 1999

Publication

% **1**

3

Xinxin Yang, Zhen Zhong. "Dynamics and Terminal Sliding Mode Control of Two-Link Flexible Manipulators with Noncollocated Feedback", IFAC Proceedings Volumes, 2013

Publication

% **1**

4

D R Parhi. "Real-time navigational control of mobile robots using an artificial neural network", Proceedings of the Institution of Mechanical Engineers Part C Journal of Mechanical Engineering Science, 07/01/2009

Publication

% **1**

5

Gervais, J.L.. "Quantum scattering of solitons",

% **1**

Nuclear Physics, Section B, 19760712

Publication

-
- | | | |
|----|--|------|
| 6 | Submitted to University of Technology, Sydney
Student Paper | % 1 |
| 7 | Submitted to University of Petroleum and Energy Studies
Student Paper | % 1 |
| 8 | Millard F. Beatty. "Principles of Engineering Mechanics", Springer Nature, 1986
Publication | % 1 |
| 9 | Submitted to Universiti Teknologi MARA
Student Paper | % 1 |
| 10 | Choi, S.B.. "Vibration control of a single-link flexible arm subjected to disturbances", Journal of Sound and Vibration, 20040406
Publication | <% 1 |
| 11 | D.B. Holmes, J.R. Vermeulen. "Velocity profiles in ducts with rectangular cross sections", Chemical Engineering Science, 1968
Publication | <% 1 |
| 12 | Submitted to Victoria University
Student Paper | <% 1 |
| 13 | Submitted to Universiti Teknologi Malaysia
Student Paper | <% 1 |
| 14 | Submitted to Northcentral
Student Paper | <% 1 |

15

pt.scribd.com

Internet Source

<% 1

16

"Vibration Dynamics and Control", Springer

Nature, 2009

Publication

<% 1

17

Roberto Caracciolo. "Experimental validation of a model-based robust controller for multi-body mechanisms with flexible links", *Multibody System Dynamics*, 09/2008

Publication

<% 1

18

ADAM KOWALEWSKI. "Feedback Control of a Distributed Parabolic System with Boundary Condition Involving a Time-Varying Lag", *IMA Journal of Mathematical Control and Information*, 1990

Publication

<% 1

EXCLUDE QUOTES ON

EXCLUDE ON

BIBLIOGRAPHY

EXCLUDE MATCHES

< 5

WORDS